

208~230V AHU KIT

Model:GMV-N48U/A-T(U)



Specifications	Unit	Parameter
Model	—	GMV-N48U/A-T(U)
Rated Cooling Capacity	kBtu/h	48
Rated Heating Capacity	kBtu/h	54
Rated Input	kW	5
Air flow volume	CFM	1236~1413
Power Supply	Voltage,Phase, Hertz	208/230, 1, 60
EXV Box Dimensions (H×W×D)	mm/inch	85×203×326 (3-3/8×8×12-7/8)
PCB Box Dimensions (H×W×D)	mm/inch	111×334×284 (4-3/8×13-1/8×11-1/8)
Connection method	—	Brazing Connection
Net Weight	kg/lbs	9.5/21
Cross-sectional Area of Power Cable Conductor	mm ² /sq.in	1.00/0.0016
Standard Controller	—	XK46
Optional Controller	—	XK79/XK55/XK86

Note : One model can match with 2 or 3 kinds of AHU, please adjust the capacity dip switch in the PCB box to adpot the corresponding AHU.

Job Name:		Date:	
System Reference No.:			
Engineer Signature:			

Outline and Physical Dimensions of GMV-N48U/A-T(U).

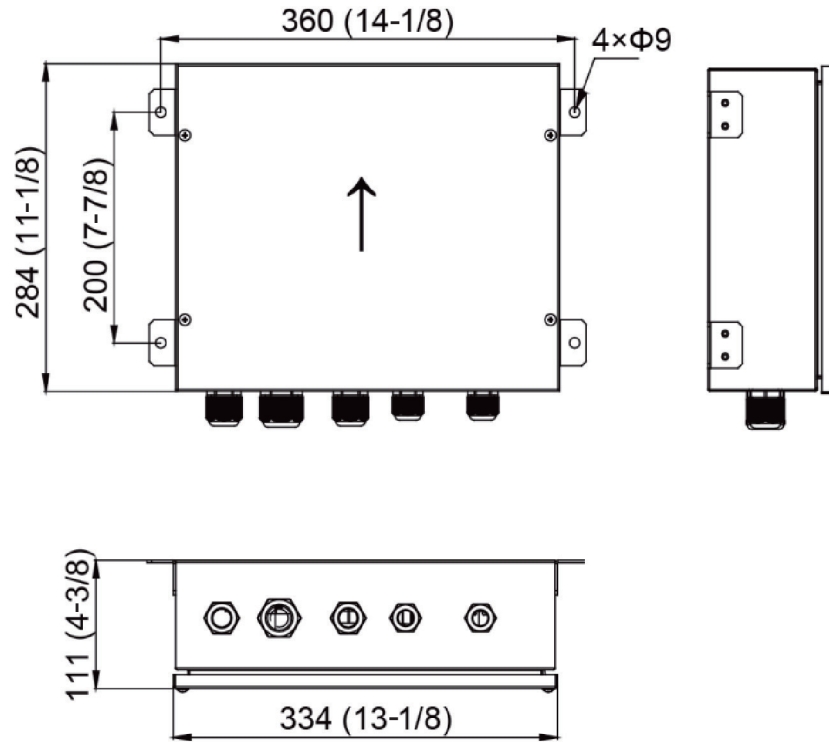

Outline and Physical Dimension of EXV Box

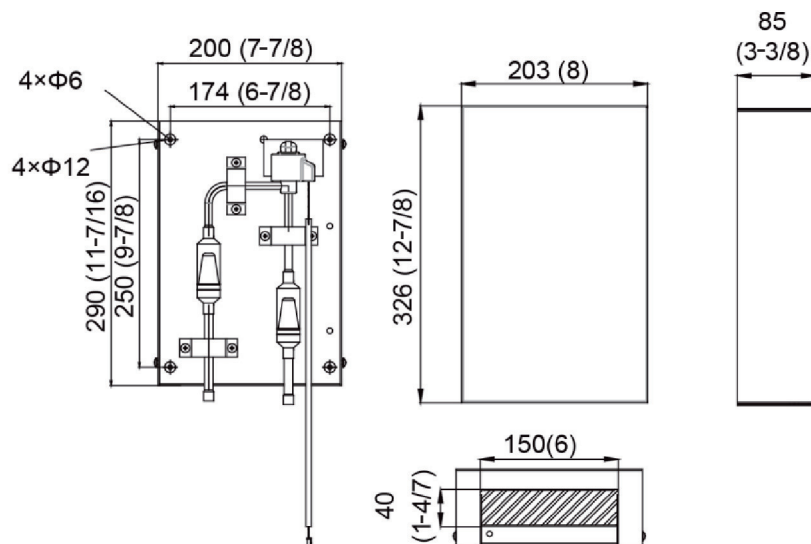

Unit:mm(in.)

