

## 208~230V Floor Ceiling

### Model:GMV-ND36ZD/A-T(U)



Specifications	Unit	Parameter
Model	—	GMV-ND36ZD/A-T(U)
<b>Performance</b>		
Rated Cooling Capacity	kBtu/h	36
Rated Heating Capacity	kBtu/h	40
Sound Pressure Level	dB(A)	42/46/51
<b>Electrical Data</b>		
Power Supply	Voltage,Phase, Hertz	208/230,1,60
Maximum Overcurrent Protection (MOP)	A	15
Minimum Circuit Amps (MCA)	A	1
<b>Fan</b>		
Type x Quantity	—	Centrifugal×4
Air Flow Volume	CFM	755/904/1180
Fan Motor Running Current	A	0.7
Fan Motor Power Output	W	250
<b>Refrigerant Piping</b>		
Connection Pipe	Gas(mm/inch)	Φ15.9/Φ5/8
	Liquid(mm/inch)	Φ9.52/Φ3/8
Connection method	—	Flare Connection
Refrigerant	—	R410A
<b>Dimension/Weight</b>		
Dimensions (H×W×D)	mm/inch	245×1700×700/ (9-5/8×66-15/16×27-9/16)
Net Weight	kg/lbs	60/132
<b>Other</b>		
Safety Certification	—	ETL

Job Name:		Date:	
System Reference No.:			
Engineer Signature:			

### Outline and Physical Dimensions of GMV-ND36ZD/A-T(U).

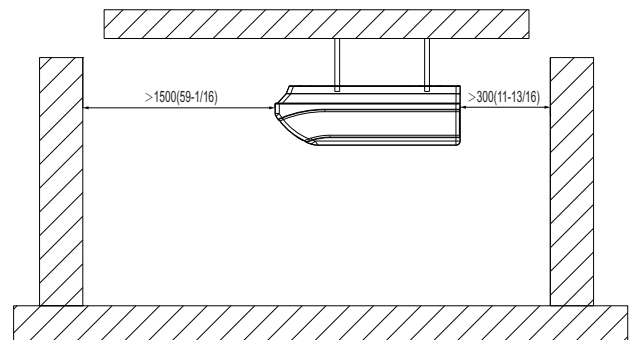
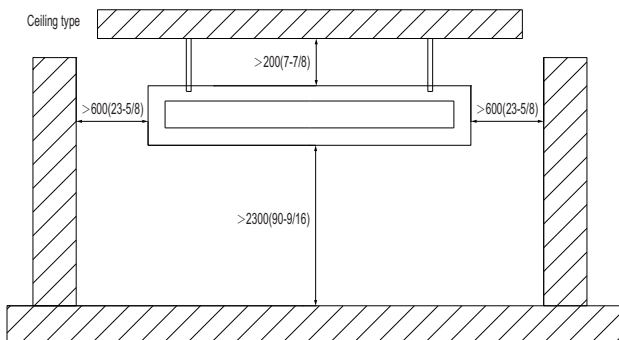
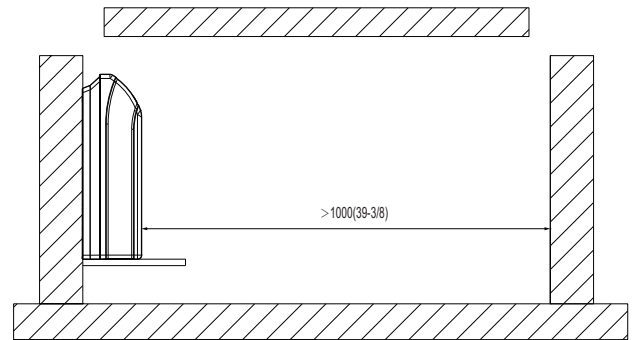
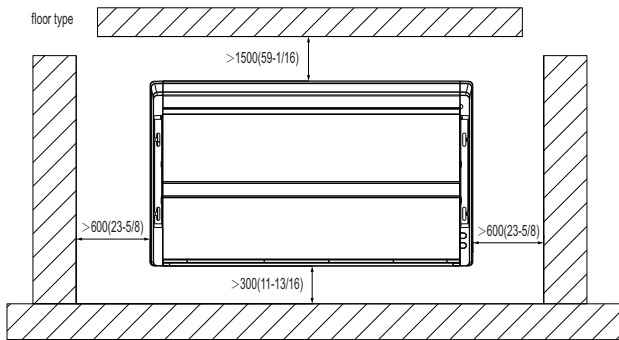
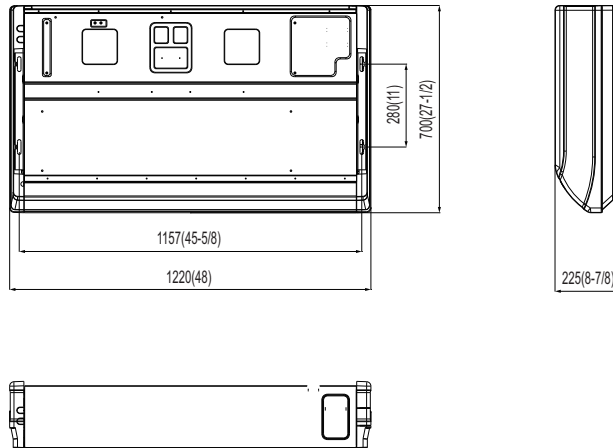

Unit:mm(in.)

