

208~230V Super High Fan Coil

Model:GMV-ND07PHS/B-T(U)



Specifications	Unit	Parameter
Model	—	GMV-ND07PHS/B-T(U)
Performance		
Rated Cooling Capacity	kBtu/h	7.5
Rated Heating Capacity	kBtu/h	8.5
Sound Pressure Level	dB(A)	31/33/35
Electrical Data		
Power Supply	Voltage,Phase, Hertz	208/230,1,60
Maximum Overcurrent Protection (MOP)	A	15
Minimum Circuit Amps (MCA)	A	1
Fan		
Type × Quantity	—	Centrifugal ×1
Air Flow Volume	CFM	235/282/323
ESP	Pa	60/0~150
Fan Motor Running Current	A	0.3
Fan Motor Power Output	W	150
Refrigerant Piping		
Connection Pipe	Gas(mm/inch)	Φ9.52/Φ3/8
	Liquid(mm/inch)	Φ6.35/Φ1/4
Connection method	—	Brazing Connection
Refrigerant	—	R410A
Dimension/Weight		
Dimensions (H×W×D)	mm/inch	300×700×700/ (11-13/16×27-9/16×27-9/16)
Net Weight	kg/lbs	33/73
Other		
Safety Certification	—	ETL

Job Name:		Date:	
System Reference No.:			
Engineer Signature:			

Outline and Physical Dimensions of GMV-ND07PHS/B-T(U).

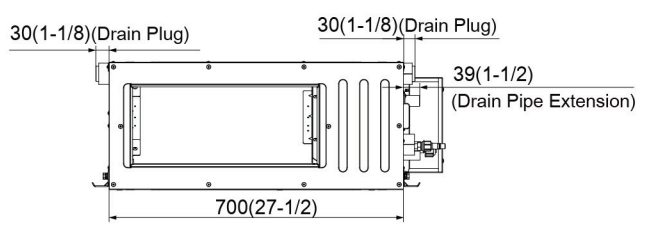
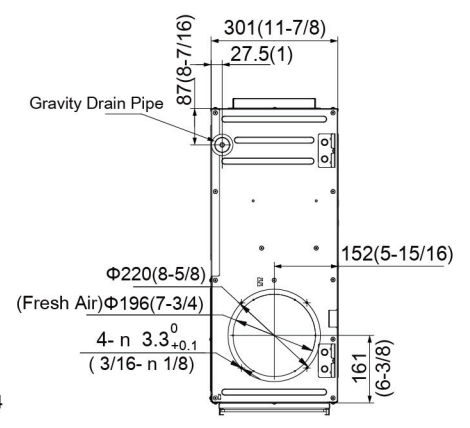
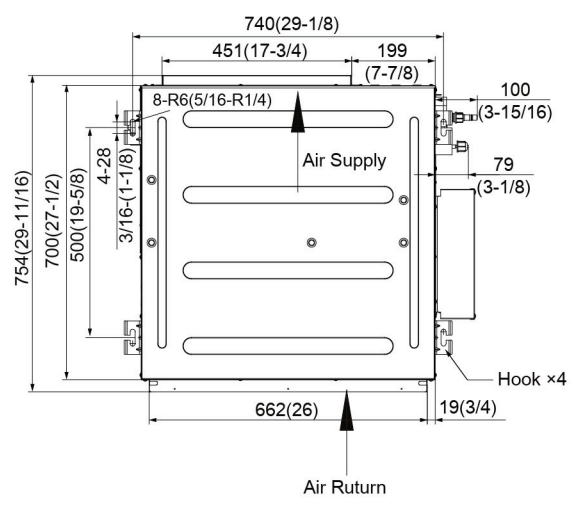
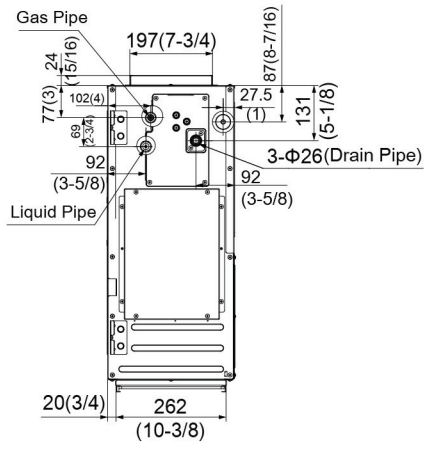
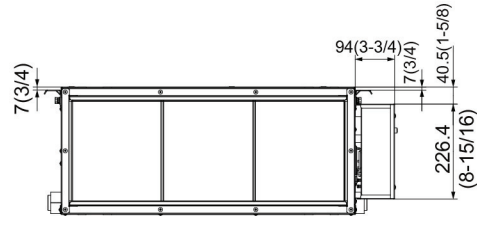

Model	Gas Pipe Diameter	Liquid Pipe Diameter
GMV-ND07PHS/B-T(U)	3/8"	1/4"

Unit:mm(in.)

